

紧凑型工控机 支持 8/10/11/12代Intel Core-i3/i5/i7

## 产品介绍

NBC-2412紧凑型工控机是一款可搭载8/10/11/12代Intel Core-i3/i5/i7高性能处理器的小型工控机，性能稳定可靠，可轻松应用各种应用程序。配备 6x COM, 2x LAN, 8x USB, 1x VGA, 1x HDMI, 2x CAN2.0 (选配), 16x 带隔离DIO(选配)等丰富接口，可满足用户各种应用扩展。整机采用紧凑型无风扇设计，以灵活的客制化方案，能在有限的尺寸内提供必要的接口功能和算力，为狭小安装空间应用提供最优解决方案。

## 特点

- 支持 8/10/11/12代Intel® Core™ i3/i5/i7 处理器
- 6x COM, 2x LAN, 8x USB, 1x VGA, 1x HDMI
- 2x CAN2.0 (选配), 16x 带隔离DIO(选配)
- 9 ~ 36VDC 电源输入



工作温度



电源输入



无风扇



## 图像展示



## 技术参数

<b>系统</b>				
CPU	Intel® Core™ i3-8145U /i5-8265U	Intel® Core™ i3-10110U /i5-10210U/i7-10510U	Intel® Core™ i3-1115G4/ i5-1145G7/i7-1185G7	Intel® Core™ i3-1215U/ i5-1235U/i7-1255U
CPU TDP	15W			
内存	1x DDR4 2666 MHz SO-DIMM 最大支持32GB		1x DDR4 3200 MHz SO-DIMM 最大支持32GB	
存储	1x mSATA		1x M.2 2280 NVME	
BIOS	AMI UEFI			
Watchdog Timer	软件可编程支持256级系统复位			
<b>I/O 接口</b>				
USB	6x USB 2.0, 2x USB 3.0			
串口	6x RS-232 (1x RS-232/422/485)		6x RS-232 (1x RS-232/422/485, 1x RS-232/485)	
网口	2x RJ45 GbE Intel® I226-V			
显示接口	1x VGA, 1x HDMI			
SIM 卡槽	1x SIM card slot(选配)			
DIO	16x 带隔离 DIO(选配)			
CAN bus	2x CAN 2.0B(选配)			
天线孔	3x SMA 天线孔			
<b>扩展槽</b>				
Mini PCIe	1x Full length mini PCIe		N/A	
M.2	N/A		1x M.2 2230 E-Key/1x M.2 2280 NVME	
<b>无线通讯</b>				
Wi-Fi	Mini PCIe		M.2 2230 E-Key	
Cellular	Mini PCIe			
Bluetooth	Mini PCIe		M.2 2230 E-Key	
GNSS	Mini PCIe			
<b>音频</b>				
Audio	Mic in, line out			
<b>电源规格</b>				
按键	Yes			
远程电源开关	4-Pin 远程开关&LED电源灯			
电源输入	9-36VDC			
电源工作模式	AT/ATX			
<b>操作系统</b>				
Windows	Windows 10/11			
Linux	Ubuntu			
<b>产品规格</b>				
外观尺寸 (W x D x H)	200 x 154 x 56 mm			
重量	2 kg			
安装方式	壁挂式			
材质	铝合金			
<b>环境规格</b>				
工作温度	-10 to 60°C			
储存温度	-20 to 60°C			
相对湿度	10% to 95% @ 40°C , 无冷凝			
<b>认证</b>				
EMC	CE, FCC Class A			

## 尺寸图

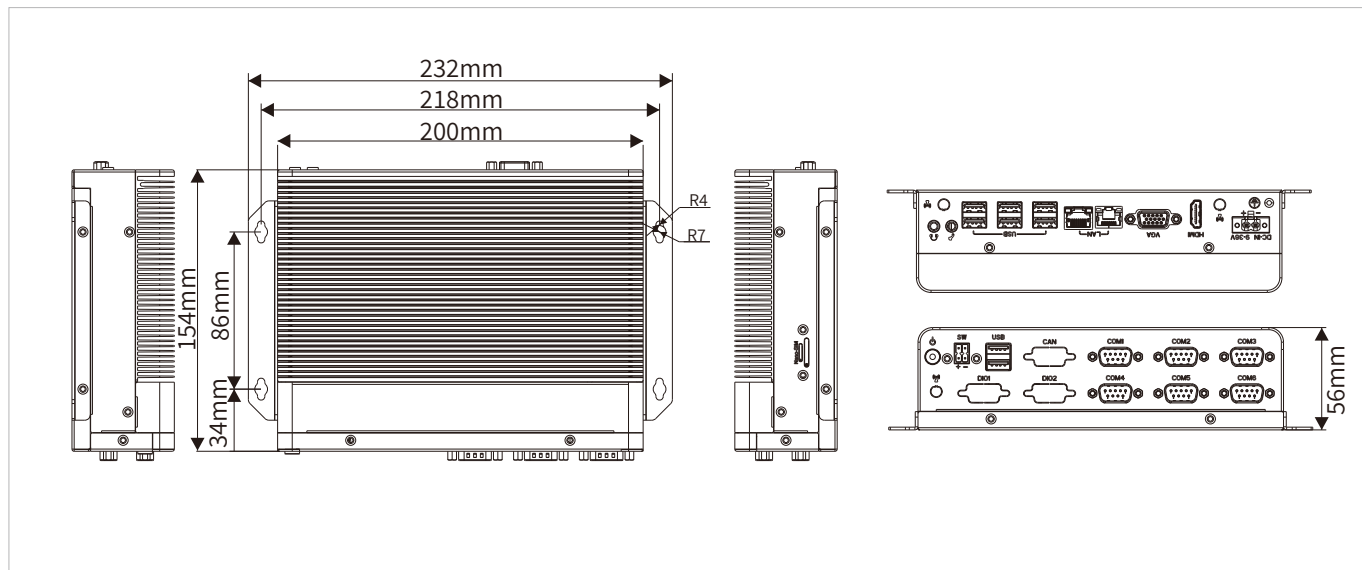

## 可选配件

料号	描述
A.02.001.000058	110-240VAC Input, 12VDC/5A Output, 60W, Phoenix 2P Terminal Block Connector(5.0)
C.02.009.000094	110-240VAC Input, 12VDC/7A Output, 84W, Phoenix 2P Terminal Block Connector(5.0)

## 订购信息

料号	描述
NBC-2412-8145U	Core™ i3-8145U NBC with 6x COM, 2x LAN, 8x USB, 1x VGA, 1x HDMI, 9 to 36VDC
NBC-2412-8265U	Core™ i5-8265U NBC with 6x COM, 2x LAN, 8x USB, 1x VGA, 1x HDMI, 9 to 36VDC
NBC-2412-10110U	Core™ i3-10110U NBC with 6x COM, 2x LAN, 8x USB, 1x VGA, 1x HDMI, 9 to 36VDC
NBC-2412-10210U	Core™ i5-10210U NBC with 6x COM, 2x LAN, 8x USB, 1x VGA, 1x HDMI, 9 to 36VDC
NBC-2412-10510U	Core™ i7-10510U NBC with 6x COM, 2x LAN, 8x USB, 1x VGA, 1x HDMI, 9 to 36VDC
NBC-2412-1115G4	Core™ i3-1115G4 NBC with 6x COM, 2x LAN, 8x USB, 1x VGA, 1x HDMI, 9 to 36VDC
NBC-2412-1145G7	Core™ i5-1145G7 NBC with 6x COM, 2x LAN, 8x USB, 1x VGA, 1x HDMI, 9 to 36VDC
NBC-2412-1185G7	Core™ i7-1185G7 NBC with 6x COM, 2x LAN, 8x USB, 1x VGA, 1x HDMI, 9 to 36VDC
NBC-2412-1215U	Core™ i3-1215U NBC with 6x COM, 2x LAN, 8x USB, 1x VGA, 1x HDMI, 9 to 36VDC
NBC-2412-1235U	Core™ i5-1235U NBC with 6x COM, 2x LAN, 8x USB, 1x VGA, 1x HDMI, 9 to 36VDC
NBC-2412-1255U	Core™ i7-1255U NBC with 6x COM, 2x LAN, 8x USB, 1x VGA, 1x HDMI, 9 to 36VDC